

NOVASAIL

NS350

Operating Manual

Contents

Introduction	3
Installation	4
Controls and display description	5
• Modes and sub-modes.....	5
Operations	6
• Switching power on and off	6
• Switching backlight on and off.....	7
• Switching modes and sub-modes	7
• Magnetic heading compass mode.....	8
• Wind shift indicator mode	8
• Tack incator mode	10
• ROLL angle indicator mode.....	12
• TIMER mode	13
Advanced Operations	14
• SET mode	14
• Exit timer mode	15
• Tack mode timer threshold	16
• Enable or disable the race functions	16
• Reset to factory compass calibration values.....	17
User calibration of the magnetic compass	17
Document History	24
Limited Warranty	26
Disclaimer	27

With the *NS350*, you can find a magnetic compass along with the all-essential race functions : wind shift indicator, direction, tactical compass and race timer.



Compact (125mm x 80mm x 26mm) and intuitive, the *NS350* is lighter (190 grams) than any existing system, wired or wireless. It is also waterproof and robust, being made of bombproof polycarbonate and anodized aluminium.

Powered with only one AA battery, the *NS350* gives sailors accurate information for over 150 hours and can be installed in minutes.

We hope you enjoy sailing with the *NS350*, and encourage you to read this manual thoroughly to learn about the many features of your exciting new Novasail product.

Installation

The mounting location should be as far as possible from any magnetic objects to avoid any interference with the compass sensor.

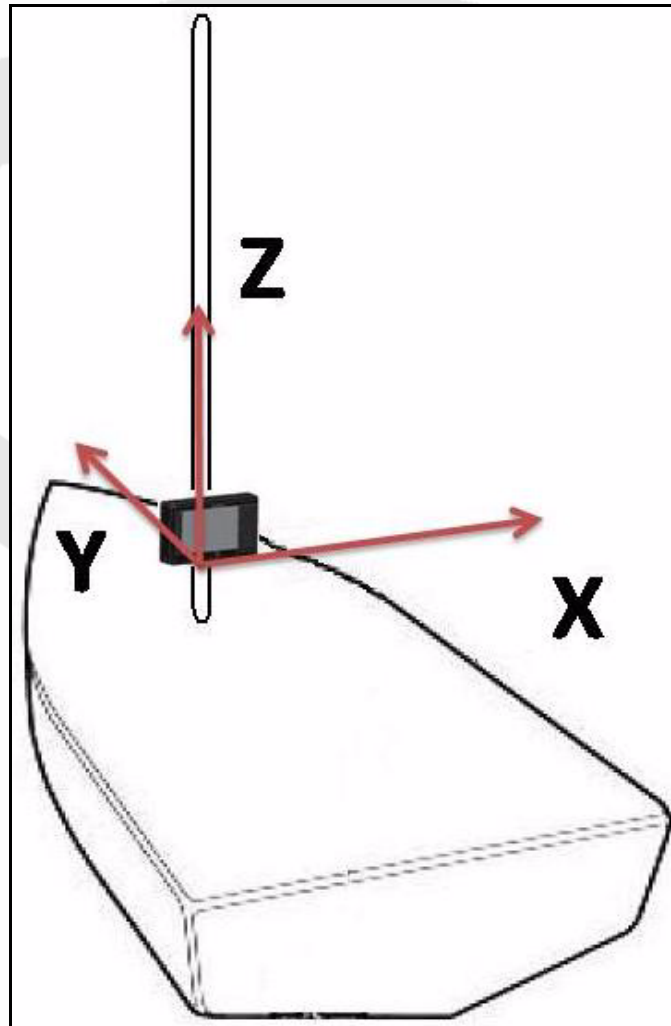

The *NS350* should be mounted as close as possible to the vertical and horizontal planes.

Controls and display description

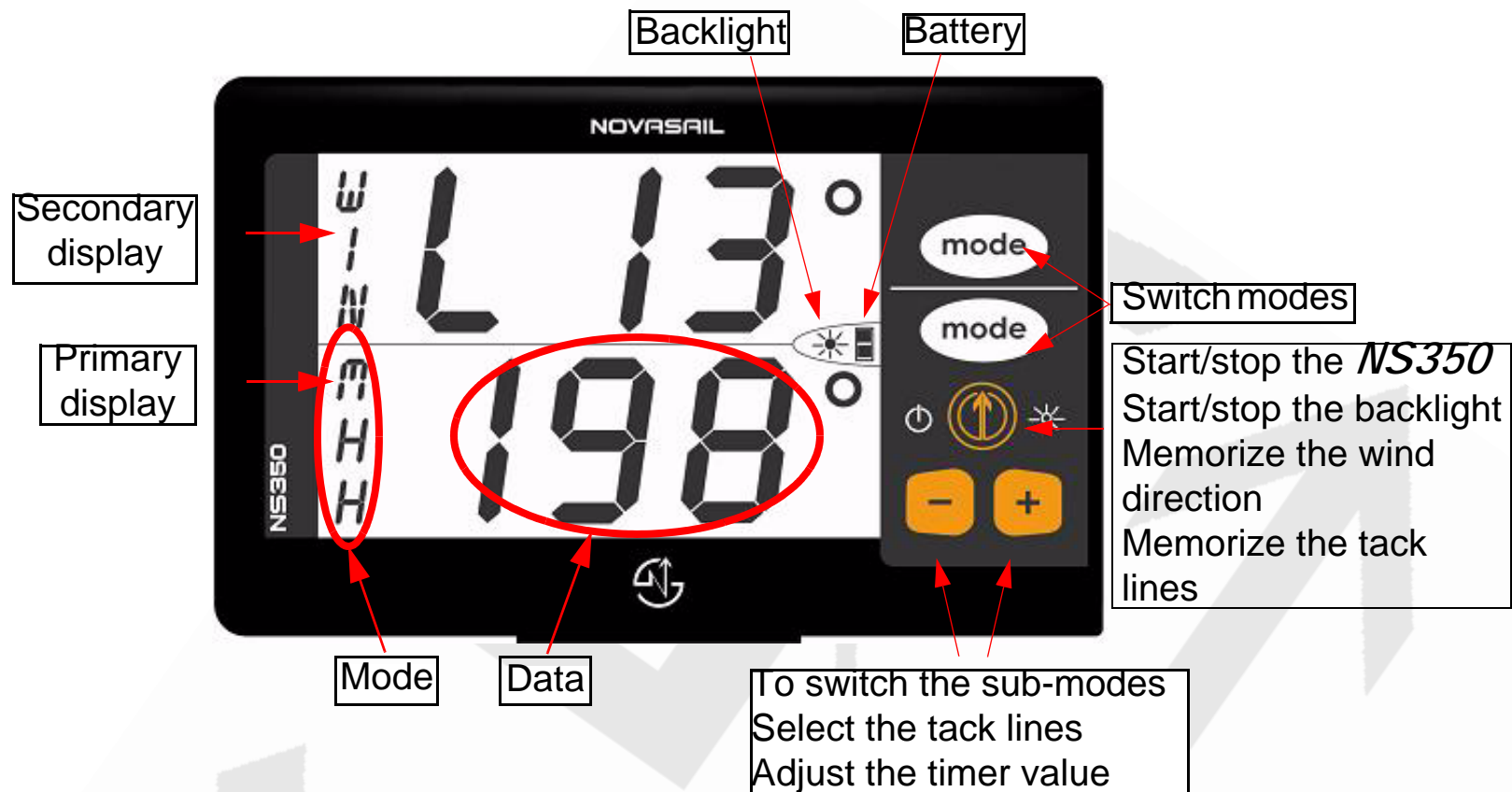

Modes and sub-modes

Magnetic Heading :

- **MHH** : High sensitivity
- **MHM** : Medium sensitivity
- **MHL** : Low sensitivity

MH

Wind Shift Indicator :

WIN

Tack Indicator :

TAK

Roll angle indicator :

ROL

TIMER :



TIM

Operations

Switching power on and off

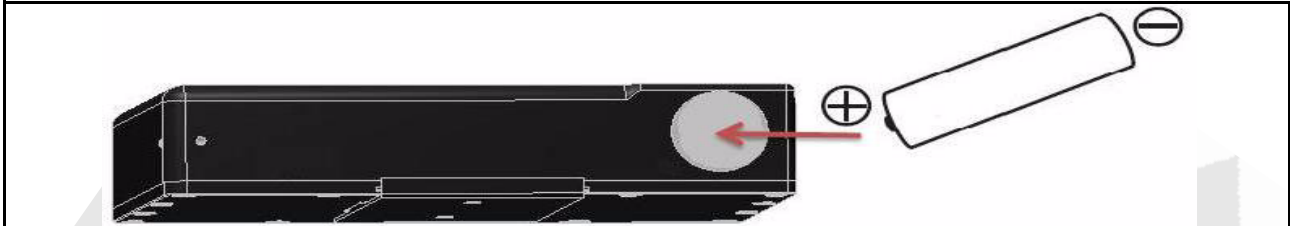
- Make sure the battery is installed with the correct polarity and has enough remaining power (positive pole inserted first).



- Press  to start the device. A beep will be emitted.
- Press and hold  for more than 4 seconds until the screen displays OFF and the sequence “3”, “2”, “1” is finished. A beep will be emitted when the device turns off.





The device will turn off automatically when it remains in the horizontal position for more than 3 minutes. A beep will be emitted 3 seconds before it turns off.

Note : If the device does not turn on, you need to check if the battery is fully charged, that the battery compartment is dry, and the polarity is correct.

Note : Alkaline batteries should be used in order to result in a maximum lifespan of 150 hours. When using a disposable battery, it is also recommended to remove it if the device is not used for a prolonged period of time (in order to avoid a possible leakage inside the battery compartment).





If using rechargeable batteries, low self discharge rate battery types are preferred, because normal rechargeable batteries lose their stored energy more quickly. Recommended batteries are SANYO ENELoop, GP RECYKO+ or UNIROSS HYBRIO. This kind of rechargeable battery will last for approximately 100 hours.

Switching backlight on and off

- Press and hold  for more than 1 second until the icon  is displayed on the screen. If the OFF sequence starts, simply release the button  before the sequence “3”, “2”, “1” is finished.
- To turn off the backlight, press and hold  for more than 1 second until the icon  disappears from the screen.

Note : When you press and hold the select button to switch on/off the backlight, you will not make any selection and therefore will not change any parameter.

Switching modes and sub-modes

- To have two different separate readings, first choose the mode and sub-mode required on the primary display by pushing  and then the arrows   for the sub-mode selection. Then, display the selected sub-mode on the secondary display using the  button.
- You are free to choose another mode/sub-mode on the primary display.

Note : Any sub-mode selection on the primary display will affect automatically the secondary display when both displays are in the same mode.

Operations

Magnetic Heading compass mode

To win races you need to react to even small wind shifts. The **NS350** digital compass delivers precise and reliable heading information to help you to tack and gybe at the most suitable times.

The sensitivity of the compass can easily be adjusted to High, Medium or Low by scrolling through the sub-modes.

- Use the arrows   to scroll the sub-modes.

Sub-modes of the Magnetic Heading compass :

- **MHH** : **M**agnetic **H**eading **H**igh sensitivity

When sailing with light winds and flat seas, High sensitivity allows you to appreciate very small wind variation.

- **MHM** : **M**agnetic **H**eading **M**edium sensitivity

Medium sensitivity is more suitable for race boats under medium wind and sea conditions. Dinghy racers will appreciate this mode.





- **MHL** : **M**agnetic **H**eading **L**ow sensitivity

Under Low sensitivity more subtle variations due to big waves and sudden gusts are filtered.

WINd shift indicator mode



Used in Wind Shift Indicator (WIN) mode, the **NS350** displays numerical values of the wind shifts allowing an immediate and effortless interpretation. To use this mode, you need to memorize the tack lines on starboard and port.

Memorization of the tack lines :

- Sail upwind to your optimal VMG.
- “D 1” is displayed on the data line of the lower screen.
- Press  to use the current magnetic compass heading as the one of the tack line directions.
- The wind shift value is immediately displayed.
- Press the arrows   to display “D 2” on the data line of the lower screen.
- Sail upwind to your optimal VMG on the other tack line.
- Press  to use the current magnetic compass heading as the other tack line direction.

Note : The sequence of memorization of the tack lines on starboard and port is not defined. You can do starboard then port or vice versa.

The WIN mode displays an angle in degrees which corresponds to the difference between the tack line direction and the current magnetic compass heading of the boat. It displays 'H' (for Heading) in front of the value if the wind is heading, and 'L' (for Lift) in front of the value if the wind is lifting. When sailing upwind, you need to sail inside the lifts 'L'.

When sailing down-wind,  (Port) or  (Starboard) will be displayed on the screen, followed by the the value of the deviation from the wind direction .

*Note : The first tack line memorized is by default considered to be the starboard line. However, if this was the port tack line, the **NS350** will understand it automatically.*

Operations

fig.1 WIN mode diagram when sailing on starboard

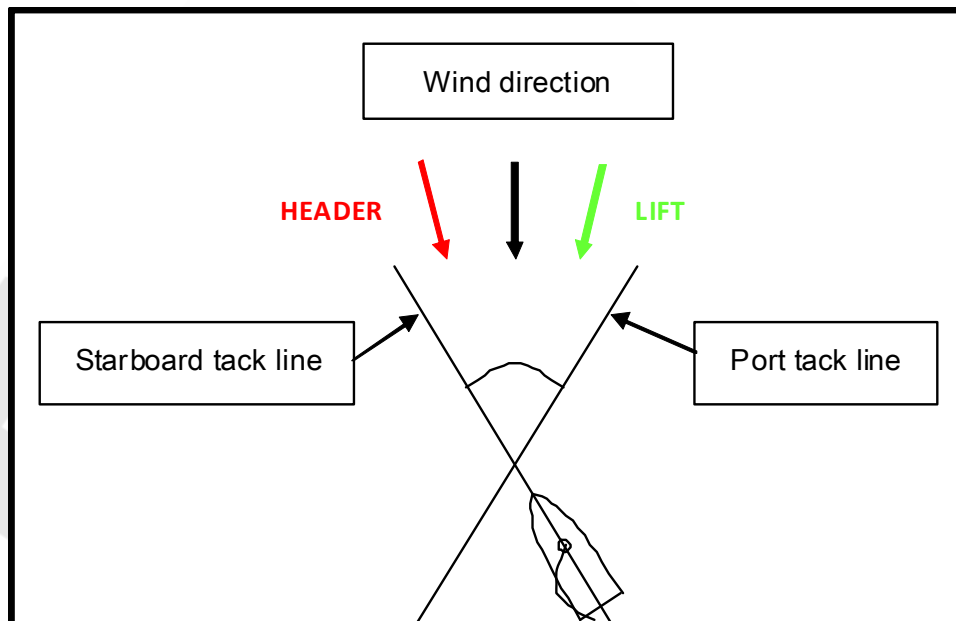

Tack indicator mode : TAK

Used in tack indicator mode (TAK), the *NS350* displays :

- The time elapsed when the boat is sailing into a heading wind compared to the average wind direction.
- The angle (bar graph) with the mean wind direction into a lifting wind.

This mode is particularly useful in order to minimize the time spent in a heading wind, allowing an immediate action (tacking).

Note : To use this mode, the tack lines on starboard and port must have been memorized in WIN mode.

When the boat is in a lifting wind, the display will show a bar graph. Each bar (maximum 6 bars) corresponds to 5 degrees. 6 bars displayed means that the boat is sailing in a wind lifting at least 25 degrees compared to the average wind direction. 1 bar indicates that the wind is lifting up to 5 degrees port or starboard direction.

fig.2 TAK mode display when sailing with a lift wind on starboard

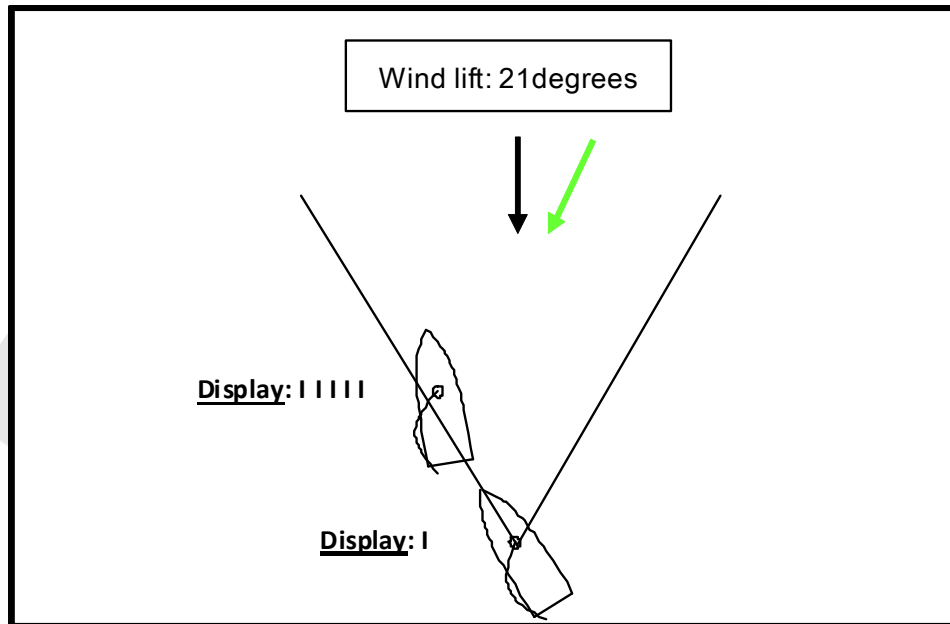
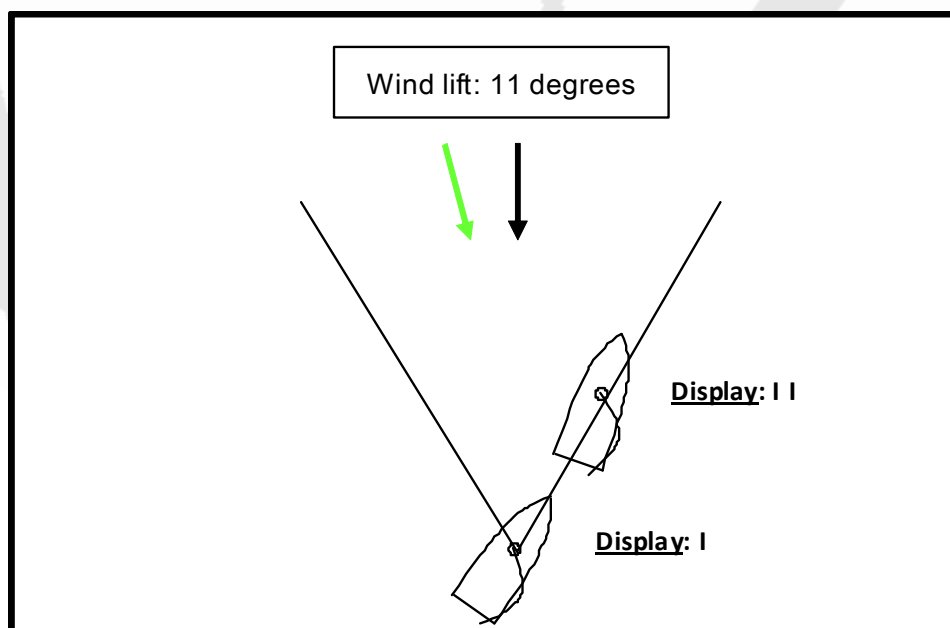

fig.3 TAK mode display when sailing with a lift wind on port





When the boat is in a heading wind, the time spent in seconds is displayed. If the value is greater than the threshold value set in SETUP mode, the timer value and 'TAK' are displayed alternatively (see "SET mode", page 14). If the boat goes

Operations

back to the lifting and the heading wind area again, the timer will restart up-counting from 0. The maximum value of the timer is 90 seconds.

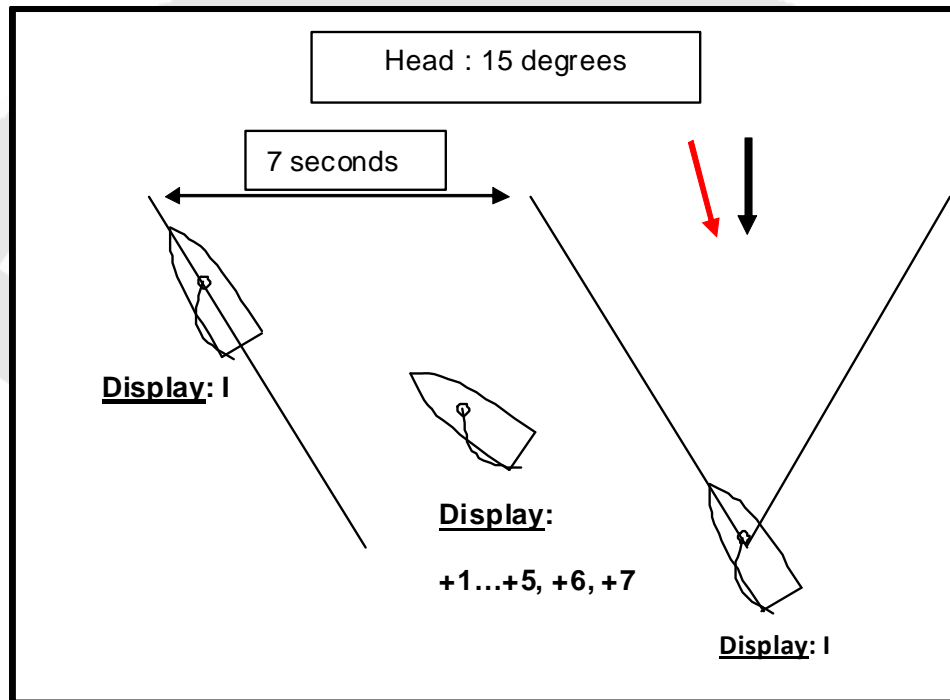
fig.4 TAK mode display when sailing with a head wind



When sailing down-wind,  (Port) or  (Starboard) will be displayed on the screen, followed by the value of the deviation from the wind direction.

Roll angle indicator mode : ROL

Used in Roll angle indicator (ROL) mode, the *NS350* displays the roll angle of the boat. The angle range can vary from 0 to 70 degrees; if the angle is greater than 70 degrees, the value blinks and remains unchanged.

TIMER mode



This mode offers a countdown timer which can be set from 1 to 9 minutes. When counting down, a short beep sounds :

- each minute until the last minute
- each ten seconds until 10 seconds
- each second until the start time

At the start time :



- a long beep sounds
- the timer starts counting the race duration in minutes and hours

Adjust, start and stop the TIMER :

- Adjust the timer value with the arrows  
- Press  to start and stop the TIMER.

Resynchronize the TIMER to the nearest minute :

When the TIMER is running, at any time you can resynchronize to the upper or lower minute

- Press the arrow  to resynchronize the value to the **upper** minute.
- Press the arrow  to resynchronize the value to the **lower** minute.

Note : *The timer continues to count down until you press  to stop it, even during resynchronization. When stopped, the display blinks and the timer remains frozen.*

Note : *After the start, the timer will switch automatically to the mode defined in the SET mode. Please refer to the Advanced Operations “Exit Timer mode”, page 15 for more details. (The default value of the Exit Timer mode parameter is “WIN” mode).*

Advanced Operations





SET mode

The **SET** mode allows the adjustment of your *NS350* parameters sequentially as follows :

- Exit mode of the Timer
- Threshold value for the TAK mode
- Race functions activation : on/off
- Reset the product to the factory default values
- Compass calibration

Note : Race functions can be turned off if your sailing class does not allow them. OFF is displayed when you select any mode using the Race functions.

To enter the SET mode :

- Press  and the upper screen  simultaneously. "SET" is displayed on the data line of the upper screen .
- Each parameter is displayed on the mode line of the lower screen.
- Select the required value for each parameter using the arrows   .
- Press  to memorize the parameter value and switch to the next parameter.
- You exit the **SET** mode automatically after the last parameter is memorized.

Note : Each parameter is memorized when  is pressed and before the next parameter is displayed, except for reset and calibration.

Name	Display	Description
Exit Timer mode	WIN	- Default alternate mode is the WIN mode - All other modes can be selected

Advanced Operations







Tack mode Timer threshold	TAK	- Default value is 10 seconds - Adjustable from 1 to 90 seconds
RACe functions activation	RAC	- ON - OFF (if your sailing class does not allow it during races)
RESet to factory default values	RES	- ON to retrieve factory values - OFF by default
Compass Calibration	CAL	- ON to start - OFF by default

The *NS350* will automatically exit the SET mode upon completion of all parameters.

Note : You can also exit the SET mode anytime by switching OFF and ON.

Exit Timer mode : ETI

After the start, the Timer mode is not needed anymore, for this reason the *NS350* will switch automatically to the desired exit mode by simply setting the parameter ETI (Exit Timer mode) as follows :

- Switch off your *NS350*
- Press  and the upper screen  simultaneously. 'SET' is displayed on the data line of the upper screen.
- Press  until ETI (Exit Timer mode) is displayed on the data line of the lower screen.
- Use the arrows   to select the desired exit mode for your *NS350*.
- Press  to store the value, TAK is now displayed.
- Go through all the parameters to exit the SET mode or press and hold  for more than 4 seconds until the device turns off.







Advanced Operations

Note : Only the MH mode and not its sub-mode (MHL, MHM, MHH) can be memorized in the ETI parameter. However, the timer will switch automatically to the memorized mode and the sub-mode that you are currently using.

Note : The mode by default is MH (magnetic compass mode).

Tack mode timer threshold : TAK

When the boat is in a heading wind, the time spent in seconds is displayed. If the value is greater than the threshold value set, the timer value and 'TAK' are displayed alternatively. The value of the timer can be set from 1 to 90 seconds.

- Switch off your *NS350*
- Press  and the upper screen  simultaneously. 'SET' is displayed on the data line of the upper screen.
- Press  until TAK is displayed on the mode line of the lower screen.
- Use the arrows   to select the desired threshold value (in seconds).
- Press  to store the value, RAC is now displayed.
- Go through all the parameters to exit the SET mode or press and hold  for more than 4 seconds until the device turns off.

Enable or disable the race functions : RAC

If your boat class does not allow on board electronic navigation aids, you may be required to switch off the race functions. For more details about the modes affected when switching off the race functions, please refer to the following table.

Table 1: Race functions activation

	RAC Off
Magnetic Heading : MH (MHH/ MHM/ MHL)	On
Wind Shift Indicator : WIN	Off
Tack Indicator : TAK	Off
Roll Angle Indicator : ROL	On
Timer : TIM	On

Note : During normal usage, if you select a mode which has been disabled by setting off the race functions, then 'OFF' will be displayed on the screen.

RESet to factory compass calibration values : RES

When set to 'ON' and when the select key is pushed, the default factory calibration values of the compass are restored and the *NS350* is powered off automatically.

User CALibration of the magnetic compass : CAL

When set to ON and when the select key is pushed, the *NS350* enters a set of sub-menus to allow a user calibration of the magnetic compass. There are 10 sub-menus for which the user has to follow the sequence described below. To allow the maximum accuracy of the calibration procedure, it is recommended to perform this outdoors to avoid any magnetic disturbing fields. A wooden surface is highly recommended (e.g. a table) and it is necessary to ensure that there are no ferrous materials nearby (wrist watches should be removed).

To start with draw 2 perpendicular lines (X and Y axis) on a perfectly horizontal plan. On the lower screen of the display, the calibration sub-menu number is displayed. There are 10 steps to follow in order to complete the calibration of your

Advanced Operations

NS350. Upon completion of the sequence, the *NS350* will memorize the new values and shut down automatically. If the *NS350* is shut down during the calibration, nothing will be memorized.

Note : Whenever necessary, the factory calibration values can be restored at any time by setting the *RES* menu to *ON* in the *SET* mode.

- Step 1 : '1' is displayed on the lower screen. The *NS350* must be oriented as follows :

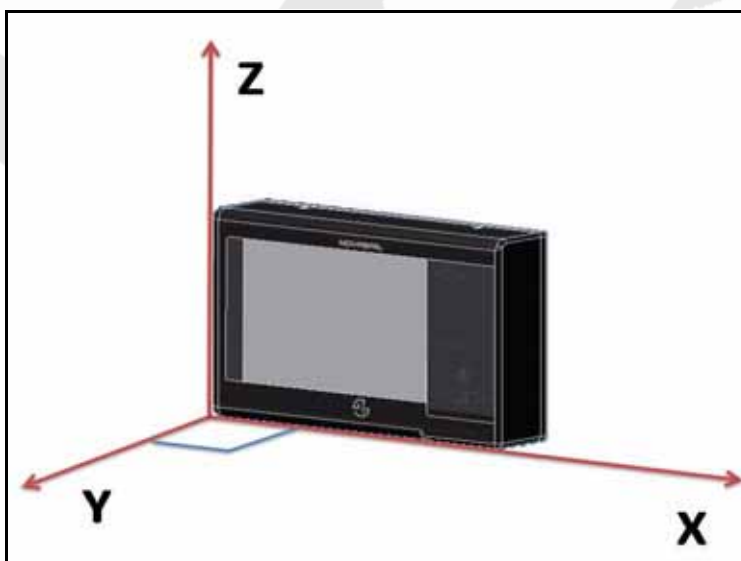

Push the select key when ready. The *NS350* will enter the calibration along the axis. After a few seconds, 3 beeps will be emitted to notify the end of step 1.

- Step 2 : '2' is now displayed on the lower screen. The *NS350* must be oriented as follows :

Advanced Operations

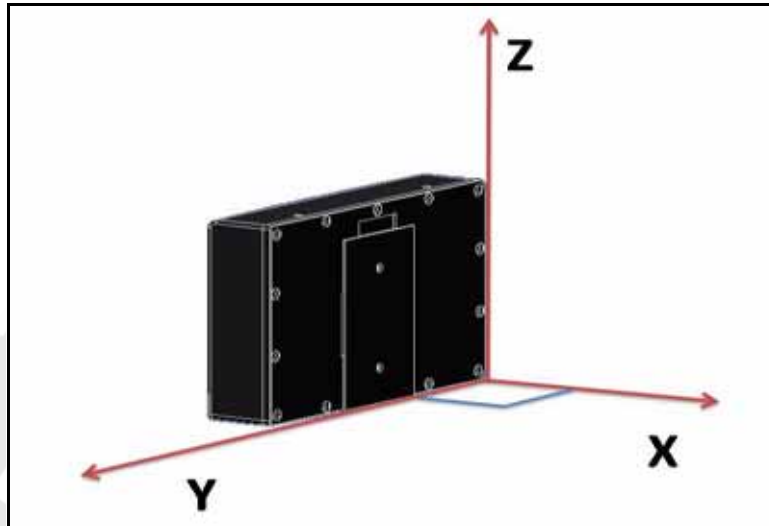

Push the select key when ready. The *NS350* will enter the calibration along the axis. After a few seconds, 3 beeps will be emitted to notify the end of step 2.

- Step 3 : '3' is now displayed on the lower screen. The *NS350* must be oriented as follows :

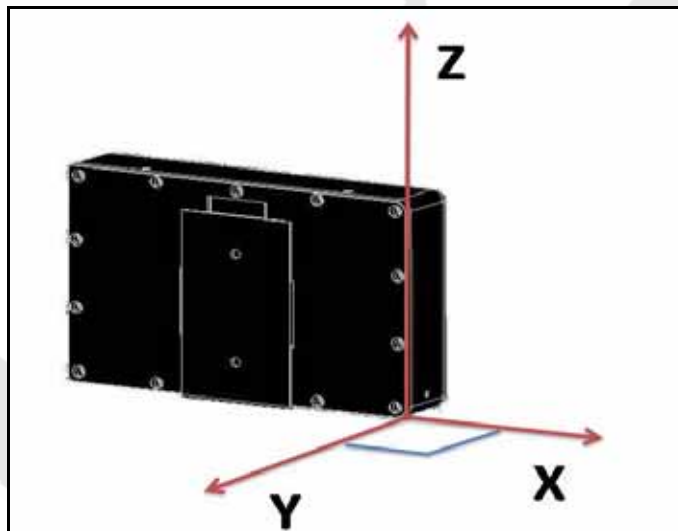

Push the select key when ready. The *NS350* will enter the calibration along the axis. After a few seconds, 3 beeps will be emitted to notify the end of step 3.

- Step 4 : '4' is now displayed on the lower screen. The *NS350* must be oriented as follows :

Advanced Operations

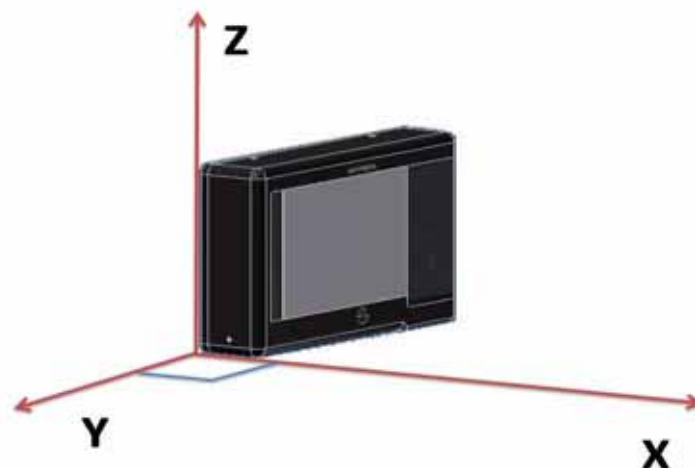

Push the select key when ready. The *NS350* will enter the calibration along the axis. After a few seconds, 3 beeps will be emitted to notify the end of step 4.

- Step 5 : '5' is now displayed on the lower screen. The *NS350* must be oriented as follows :

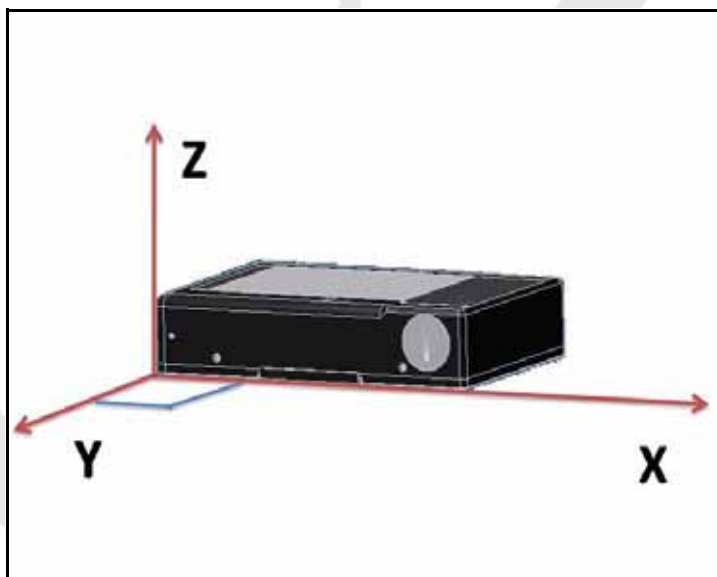

Push the select key when ready. The *NS350* will enter the calibration along the axis. After a few seconds, 3 beeps will be emitted to notify the end of step 5.

- Step 6 : '6' is now displayed on the lower screen. The *NS350* must be oriented as follows :

Advanced Operations

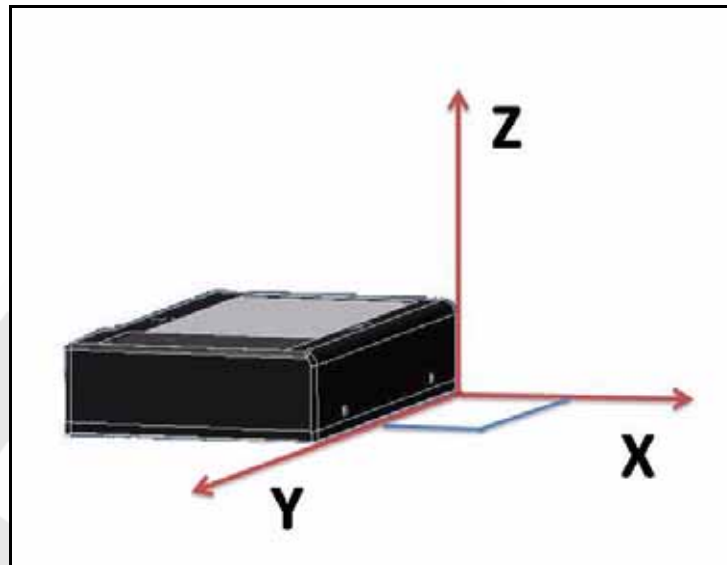

Push the select key when ready. The *NS350* will enter the calibration along the axis. After a few seconds, 3 beeps will be emitted to notify the end of step 6.

- Step 7 : '7' is now displayed on the lower screen. The *NS350* must be oriented as follows :

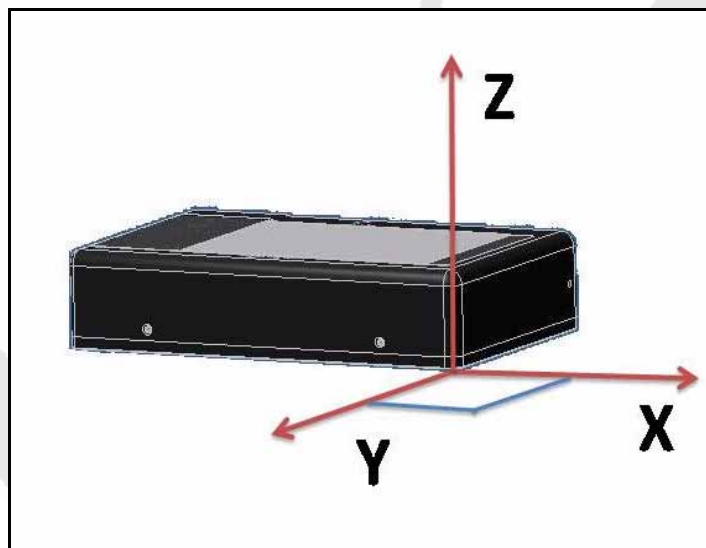

Push the select key when ready. The *NS350* will enter the calibration along the axis. After a few seconds, 3 beeps will be emitted to notify the end of step 7.

- Step 8 : '8' is now displayed on the lower screen. The *NS350* must be oriented as follows :

Advanced Operations

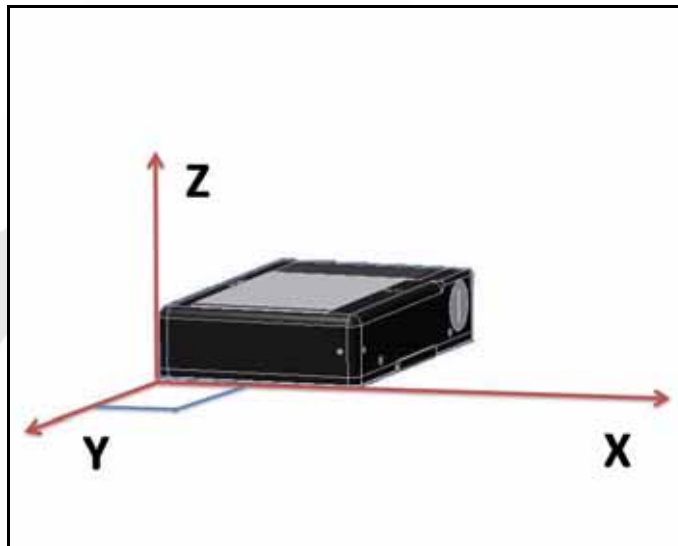

Push the select key when ready. The *NS350* will enter the calibration along the axis. After a few seconds, 3 beeps will be emitted to notify the end of step 8.

- Step 9 : '9' is now displayed on the lower screen. The *NS350* must be oriented as follows :

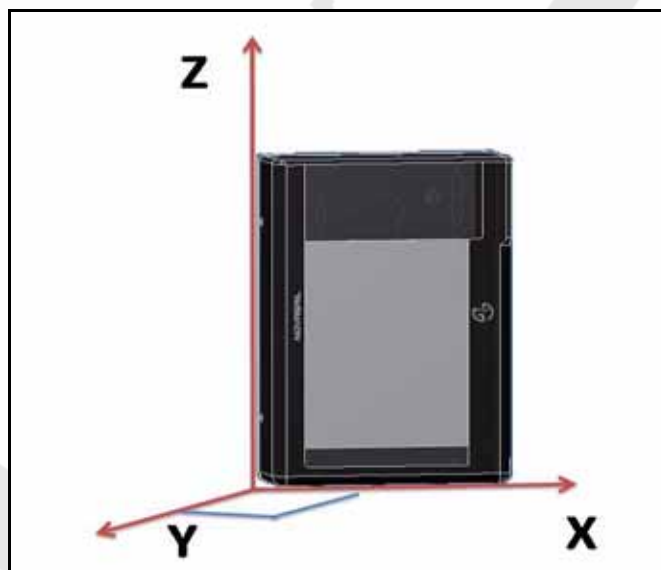

Push the select key when ready. The *NS350* will enter the calibration along the axis. After a few seconds, 3 beeps will be emitted to notify the end of step 9.

- Step 10 : '10' is displayed on the lower screen. The *NS350* must be oriented as follows :

Advanced Operations

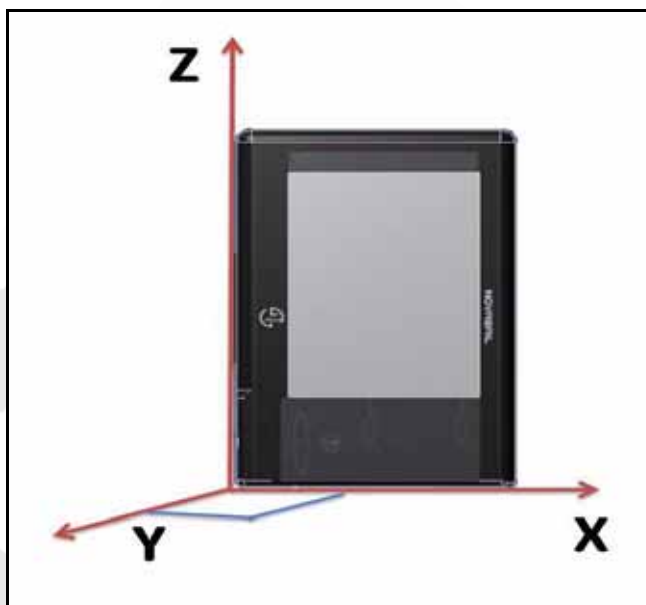

Push the select key when ready. The *NS350* will enter the calibration along the axis. After a few seconds, 3 beeps will be emitted to notify the end of step 10.

The *NS350* will store the new values and switch off automatically.

Document History

Version 1.0: First version

Version 2.0: 1/12/2009

- Updated pictures



Limited warranty

This product meets or exceeds all of Novasail's rigorous quality controls and inspection standards. Complete services will be provided in accordance with the statement of warranty set forth below if any manufacturing defect or natural failure occurs within the warranty period.

Warranty Terms and Conditions

- If any defect arises under normal conditions of use within the warranty period, our customer service center or specified partner will provide the required repair services at no charge, or legally applicable services according to the appropriate consumer protection laws and regulations of the country in which the product was purchased by the warranty holder.
- The product has to be registered using the online service available on the Novasail web site: www.nova-sail.com
- Please submit the proof of purchase (Invoice) when requesting service.
- The actual cost of repair may be charged to the customer or the performance of warranty service may be rendered impossible, even within the warranty period, under the following circumstances:
 - Product failure caused by accident or carelessness
 - Disassembly or modification for purposes other than it was originally intended for
 - Failure caused by a fire, earthquake or flood
 - Damage/failure caused by an impact
 - Failure caused by inappropriate services performed by anyone other than Novasail's customer service center or one of Novasail's service specified partners
- For assistance in obtaining service, please contact Novasail service center:

E-mail: contact@nova-sail.com
www.nova-sail.com

DISCLAIMER

Information in this document is provided solely in connection with NOVASAIL LTD products. NOVASAIL LTD reserves the right to make changes, corrections, modifications or improvements to this document and the products described herein at any time, without notice.

All NOVASAIL LTD products are sold pursuant to NOVASAIL LTD's terms and conditions of sale.

Purchasers are solely responsible for the choice, selection and use of the NOVASAIL LTD products described herein, and NOVASAIL LTD assumes no liability whatsoever relating to the choice, selection or use of the NOVASAIL LTD products described herein.

UNLESS OTHERWISE SET FORTH IN NOVASAIL LTD'S TERMS AND CONDITIONS OF SALE, NOVASAIL LTD DISCLAIMS ANY EXPRESS OR IMPLIED WARRANTY WITH RESPECT TO THE USE AND/OR SALE OF NOVASAIL LTD PRODUCTS, INCLUDING WITHOUT LIMITATION IMPLIED WARRANTIES OF MERCHANTABILITY OR FITNESS FOR A PARTICULAR PURPOSE (AND THEIR EQUIVALENTS UNDER THE LAWS OF ANY JURISDICTION).

UNLESS EXPRESSLY APPROVED IN WRITING BY AN AUTHORIZED NOVASAIL LTD REPRESENTATIVE, NOVASAIL LTD PRODUCTS ARE NOT RECOMMENDED, AUTHORIZED OR WARRANTED FOR USE IN MILITARY, AIR CRAFT, SPACE, LIFE SAVING, OR LIFE SUSTAINING APPLICATIONS, NOR IN PRODUCTS OR SYSTEMS WHERE FAILURE OR MALFUNCTION MAY RESULT IN PERSONAL INJURY, DEATH, OR SEVERE PROPERTY OR ENVIRONMENTAL DAMAGE.

Resale of NOVASAIL LTD products with provisions different from the statements and/or technical features set forth in this document shall immediately void any warranty granted by NOVASAIL LTD for the NOVASAIL LTD product or service described herein and shall not create or extend in any manner whatsoever, any liability of NOVASAIL LTD.





© 2008 NOVASAIL - All rights reserved
www.nova-sail.com